

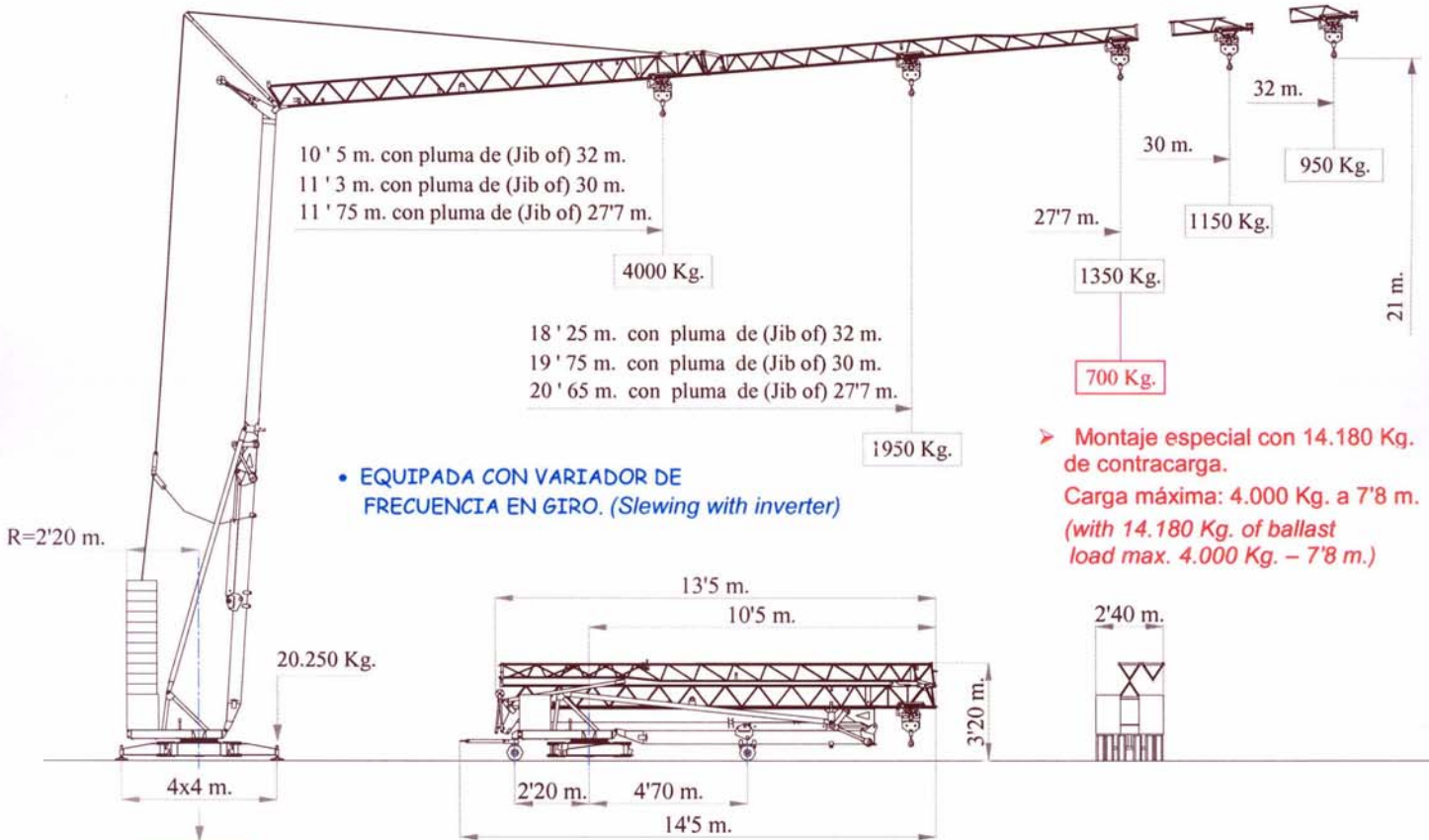

➤ Montaje especial con 14.180 Kg. de contracarga.
Carga máxima: 4.000 Kg. a 8'8 m.
(with 14.180 Kg. of ballast load max. 4.000 Kg. - 8'8 m.)

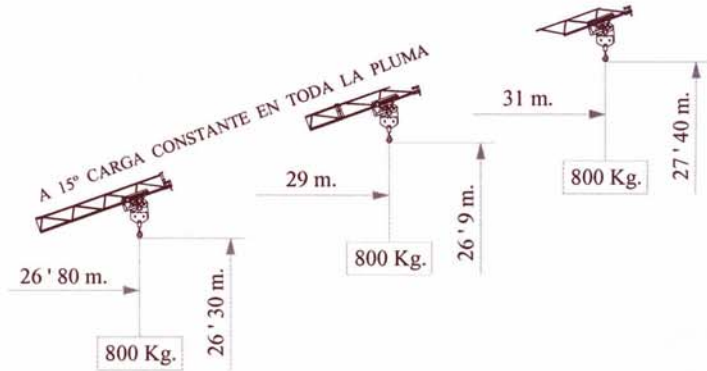

• EQUIPADA CON VARIADOR DE FRECUENCIA EN GIRO. (Slewing with inverter)

➤ Montaje especial con 14.180 Kg. de contracarga.
Carga máxima: 4.000 Kg. a 7'8 m.
(with 14.180 Kg. of ballast load max. 4.000 Kg. - 7'8 m.)

Peso de la grua (sin accesorios ni contracargas)
weight of the crane (without accessories neither ballast)









DIN 15018



EL FABRICANTE SE RESERVA EL DERECHO DE HACER CUALQUIER MODIFICACION SIN PREVIO AVISO.
subject to modifications by SISTEMAS FORZA, S.L. without previous warning.

SISTEMAS FORZA, S.L.
Ctra. de Beniaján, Km. 5, Beniaján - MURCIA (España)
Telf.: 968 - 82 08 62 / 66, Fax: 968 - 82 48 57

MECANISMOS / Mechanisms

								
Elevación Hoisting		m/min	5	20'5	41	2'5	10'25	20'5
		Kg	2000	2000	1000	4000	4000	2000
		Kw	1'8	7'5	7'5	1'8	7'5	7'5
Distribución Trolleying		m/min	19		38	19		38
		Kg	2000		2000	4000		2000
		Kw	1'1		2'2	1'1		2'2
Orientación Slewing		r.p.m	0'25	0'5	0'8	0'25	0'5	0'8
		N.m	30			30		
Montaje Erection		Kw	4			4		

Potencia requerida / Power requirement 13 Kw - 400 V - 50 Hz

DIAGRAMAS DE CARGA / Load diagrams

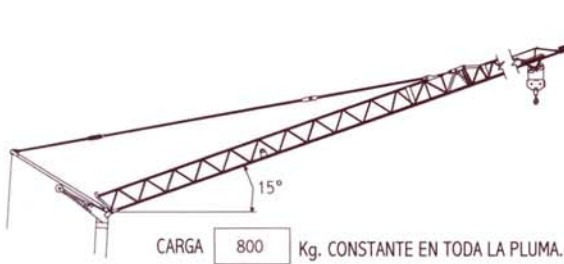

MONTAJE CON Erection with 21.580 Kg. DE CONTRACARGA. Kg. of ballast.

ALCANCE	HASTA	13'7	14'1	14'6	m.
		4000	3866	3700	Kg.

MONTAJE CON Erection with 14.180 Kg. DE CONTRACARGA. Kg. of ballast.

ALCANCE	HASTA	8'8	10'6	12'6	14'6	m.
		4000	3075	2432	2000	Kg.



ALCANCE	HASTA	10'5	12	14	16	18	18'25	20	22	24	26	28	30	32	m.
		4000	3357	2743	2309	1987	1950	1738	1540	1378	1243	1130	1033	950	Kg.
ALCANCE	HASTA	11'3	12	14	16	18	19'75	20	22	24	26	28	30	m.	
		4000	3691	3019	2545	2192	1950	1920	1703	1526	1380	1255	1150	Kg.	
ALCANCE	HASTA	11'75	12'7	14'7	16'7	18'7	20'65	22'7	24'7	26'7	27'7	m.			
		4000	3615	2994	2546	2208	1950	1733	1559	1414	1350	Kg.			

MONTAJE CON Erection with 14.180 Kg. DE CONTRACARGA. Kg. of ballast.

ALCANCE	HASTA	7'8	9'7	11'2	13	15'7	17'7	19'7	21'7	23'7	25'7	27'7	m.
		4000	2932	2397	1950	1516	1291	1118	981	870	777	700	Kg.

MONTAJE / Erection

